

WESTERN DEPOT

— FOR —

HENRY DISSTON & SONS'



KEYSTONE

SAW, TOOL, STEEL AND FILE WORKS.

Circular Saws.

Ground and Tempered.

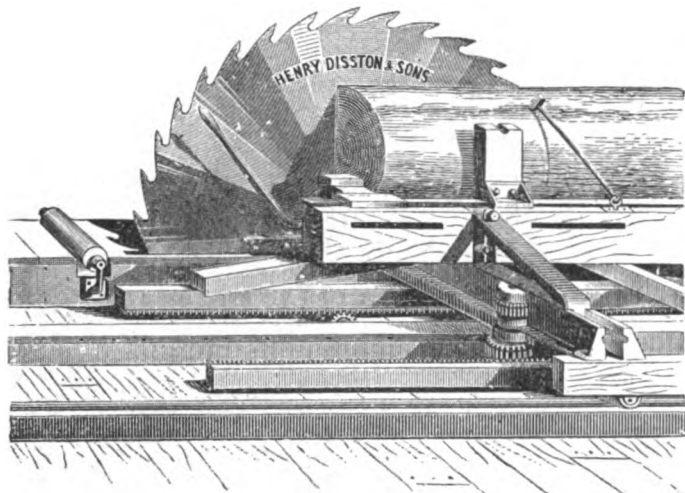

Left Hand Saw.

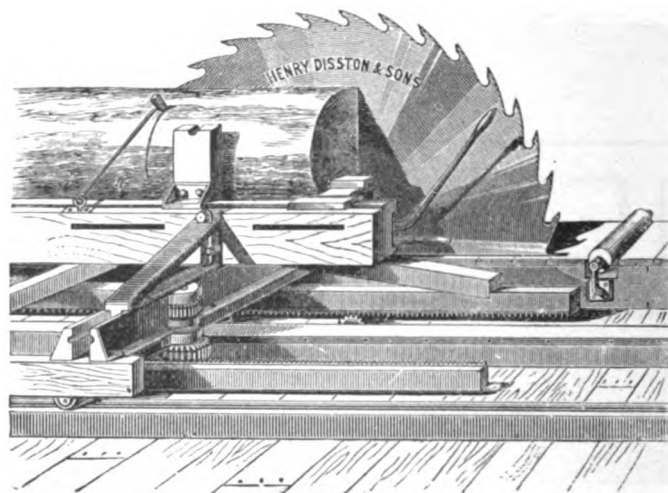

Right Hand Saw.

In ordering, be particular to state whether Right or Left Hand is wanted.

Cross-cut or Rip Circular Saws.

DIAMETER.	THICKNESS.	SIZE OF HOLE.	PRICE, EACH.	EXTRA FOR EACH ADDITIONAL GAUGE. (HEAVIER.)	PRICES FOR BEVELING NEW SAWS. PER GAUGE.
4 in.	19 Gauge.	$\frac{3}{4}$	\$0 90	\$0 08	\$0 14
5 "	19 "	$\frac{3}{4}$	1 10	04	16
6 "	18 "	$\frac{3}{4}$	1 30	05	18
7 "	18 "	$\frac{3}{4}$	1 50	06	20
8 "	18 "	$\frac{7}{8}$	1 75	08	22
9 "	17 "	$\frac{7}{8}$	2 00	10	25
10 "	16 "	1	2 30	12	28
12 "	15 "	1	3 00	17	35
14 "	15 "	$1\frac{1}{4}$	4 50	21	40
16 "	14 "	$1\frac{1}{4}$	5 50	25	50
18 "	13 "	$1\frac{1}{4}$	7 00	30	60
20 "	13 "	$1\frac{5}{8}$	8 50	35	70
22 "	12 "	$1\frac{5}{8}$	10 00	45	80
24 "	11 "	$1\frac{3}{4}$	12 00	55	90
26 "	11 "	$1\frac{3}{4}$	14 50	65	1 05
28 "	10 "	$1\frac{1}{2}$	16 00	80	1 20
30 "	10 "	$1\frac{1}{2}$	18 00	90	1 30
32 "	10 "	$1\frac{5}{8}$	20 00	1 00	1 40
34 "	9 "	$1\frac{5}{8}$	22 50	1 20	1 55
36 "	9 "	$1\frac{5}{8}$	25 50	1 40	1 70

DIAMETER.	THICKNESS.	SIZE OF HOLE.	PRICE, EACH.	EXTRA FOR EACH ADDITIONAL GAUGE. (HEAVIER.)	PRICES FOR BEVELING NEW SAWS. PER GAUGE.
38 in.	9 Gauge.	$1\frac{1}{2}$	\$30 00	\$1 75	\$1 85
40 "	9 "	2	35 00	2 00	2 00
42 "	8 "	2	40 00	2 50	2 20
44 "	8 "	2	52 50	3 00	2 40
46 "	8 "	2	60 00	3 50	2 60
48 "	8 "	2	70 00	4 00	2 80
50 "	7 "	2	80 00	4 50	3 00
52 "	7 "	2	90 00	5 00	3 25
54 "	7 "	2	100 00	6 00	3 50
56 "	7 "	2	115 00	7 00	3 75
58 "	7 "	2	130 00	8 00	4 05
60 "	6 "	2	145 00	9 00	4 35
62 "	6 "	2	160 00	10 00	4 65
64 "	6 "	2	180 00	12 00	5 00
66 "	6 "	2	200 00	15 00	5 35
68 "	5 "	2	225 00	18 00	5 75
70 "	5 "	2	255 00	21 00	6 15
72 "	5 "	2	290 00	24 00	6 55
74 "	5 "	2	330 00	27 00	7 00
76 "	5 "	2	375 00	30 00	7 50

Extra Thin Saws, also Grooving Saws, Special Prices. Circular Saws to cut Metal or Ivory, 50 per cent. advance.

No extra charge for Saws one gauge thicker than list.

Circular Saws beveled one gauge without extra charge up to 44 inches; 44 inches and larger, beveled two gauges without extra charge.

Circular Saw Mandrels.

Of the latest and most approved Style.

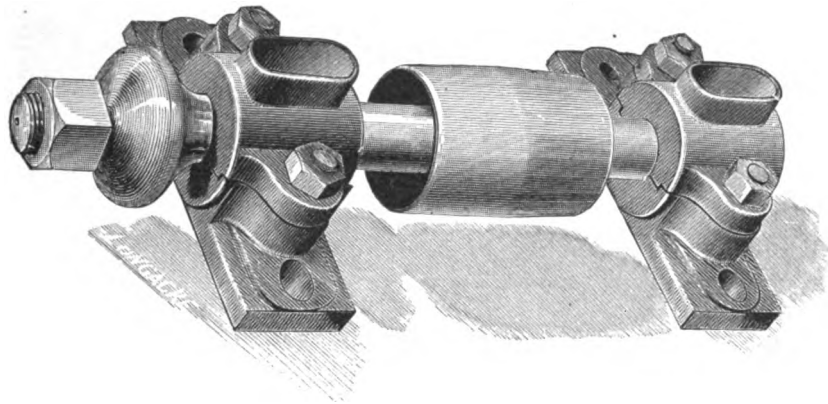

NUMBER.	DIAMETER OF PULLEY.	FACE OF PULLEY.	DIAMETER OF FLANGE.	LENGTH OF SHAFT.	DIAMETER OF SHAFT.	SIZE OF HOLE IN SAW.	PRICE, EACH.
1	2½ in.	3½ in.	2½ in.	14 in.	1 1/8 in.	1 in.	\$7 00
2	3 "	4 "	3 "	16 "	1 3/8 "	1 1/8 "	8 00
3	3½ "	4½ "	3½ "	18 "	1 5/8 "	1 1/4 "	8 50
4	4 "	5 "	4 "	20 "	1 7/8 "	1 5/8 "	9 75
5	4½ "	5½ "	4½ "	22 "	1 7/8 "	1 5/8 "	11 00
6	5 "	6 "	5 "	24 "	1 7/8 "	1 3/8 "	12 50
7	5½ "	6½ "	5½ "	26 "	1 7/8 "	1 3/8 "	13 75
8	6 "	7 "	6 "	28 "	1 9/8 "	1 1/2 "	15 50
9	7 "	8 "	6 "	32 "	1 1/8 "	1 5/8 "	21 50
10	8 "	8 "	6 "	36 "	1 3/8 "	1 5/8 "	25 75

With Pulley on End.

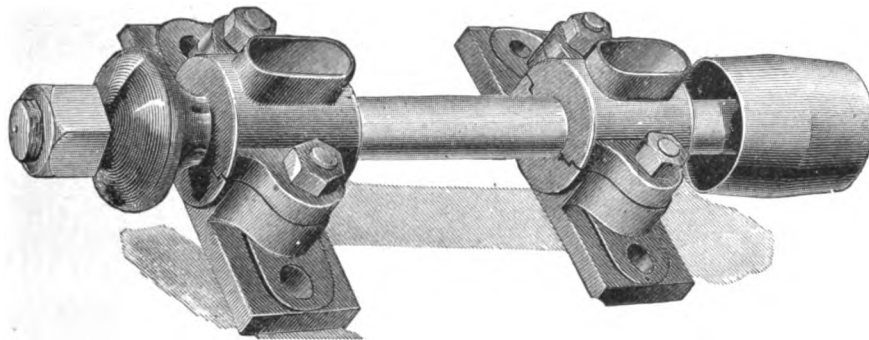

NUMBER.	DIAMETER OF PULLEY.	FACE OF PULLEY.	DIAMETER OF FLANGE.	LENGTH OF SHAFT.	DIAMETER OF SHAFT.	SIZE OF HOLE IN SAW.	PRICE, EACH.
1	2½ in.	3½ in.	2½ in.	16½ in.	1 1/8 in.	1 in.	\$7 70
2	3 "	4 "	3 "	19 "	1 3/8 "	1 1/8 "	8 50
3	3½ "	4½ "	3½ "	21½ "	1 5/8 "	1 1/4 "	9 00
4	4 "	5 "	4 "	24 "	1 7/8 "	1 5/8 "	10 75
5	4½ "	5½ "	4½ "	26 "	1 7/8 "	1 5/8 "	12 00
6	5 "	6 "	5 "	28 "	1 7/8 "	1 3/8 "	13 75
7	5½ "	6½ "	5½ "	30½ "	1 7/8 "	1 3/8 "	15 00
8	6 "	7 "	6 "	32½ "	1 9/8 "	1 1/2 "	19 50
9	7 "	8 "	6 "	37 "	1 1/8 "	1 5/8 "	23 50
10	8 "	8 "	6 "	41 "	1 3/8 "	1 5/8 "	28 00

LARGER SIZES MADE TO ORDER.

When ordering Saw Mandrels, send sketch and give distance from Saw to end of Mandrel if the pulley is between the bearings. If the pulley is on the end of Mandrel, give distance from Saw to inside edge of pulley. Also, whether the pulley is on the right or left-hand side of Mandrel when Saw is running toward you.

Our Mandrels are made with pulley on right-hand side, with left-hand thread, unless otherwise ordered.

Cross-Cut Saws.

"Simond's" Patent Crescent Ground.

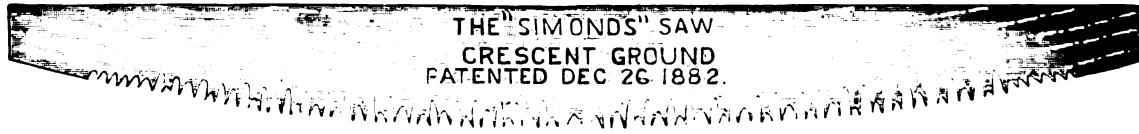

Lengths, - - -	4	4½	5	5½	6	6½	7	7½	8 ft.
Each, without Handles,	\$2 40	2 90	3 50	4 10	4 80	5 50	6 30	7 10	8 00

Atkins' Silver Steel Diamond.



Thin Back, Graduated from 14 to 18 Gauge, Complete with Handles and Raker Gauge, Lengths, 5, 5½, 6, 6½ and 7 feet, Per foot, \$1 00

Atkins' Special Steel Diamond.

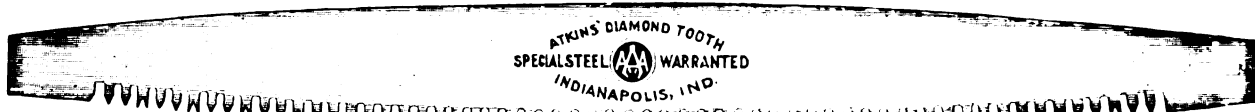

Thin Back, Graduated from 14 to 18 gauge, Without Handles, Lengths, 5, 5½, 6, 6½ and 7 feet, - - - Per foot, 65

Atkins' Patent Concave Tooth Dexter.



Thin Back, Graduated from 14 to 18 gauge, Without Handles, Lengths, 5, 5½, 6, 6½ and 7 feet, - - - Per foot, 85

Atkins' Tuttle or Champion Tooth, with Diamond Point.



Thin Back, Graduated from 14 to 18 gauge, Without Handles, Lengths, 5, 5½, 6, 6½ and 7 feet, - - - Per foot, 55

Atkins' Electric Tooth.



Thin Back, Graduated from 14 to 18 gauge, Without Handles, Lengths, 5, 5½, 6, 6½ and 7 feet, - - - Per foot, 55

Atkins' Hollow Back Champion.

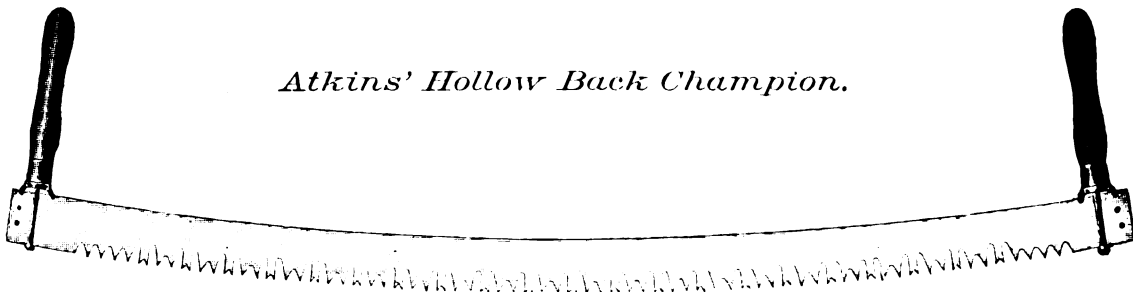

Lengths, - - -	5	5½	6	6½
Each, with Handles, - - -	\$1 50	1 65	1 80	1 95

Cross-Cut Saws.

Disston's Champion.

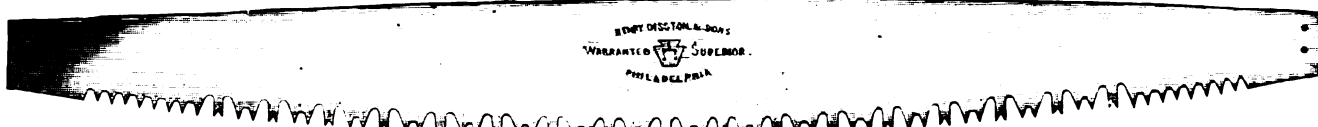

Extra Thin Back, Without Handles, Lengths, 4, 4½, 5, 5½, 6, 6½ and 7 feet, Per foot, \$0 60

Wheeler, Madden & Clemson's Champion Tooth.

Extra Thin Back, Without Handles, Lengths, 4, 4½, 5, 5½, 6, 6½ and 7 feet, Per foot, 60

Disston's Common Tooth.

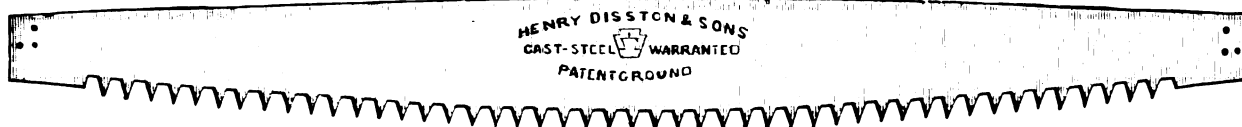

Without Handles, Lengths, 4, 4½, 5, 5½, 6, 6½ and 7 feet, Per foot, 60

One Man Saws.

Atkins' Tuttle or Champion Tooth.

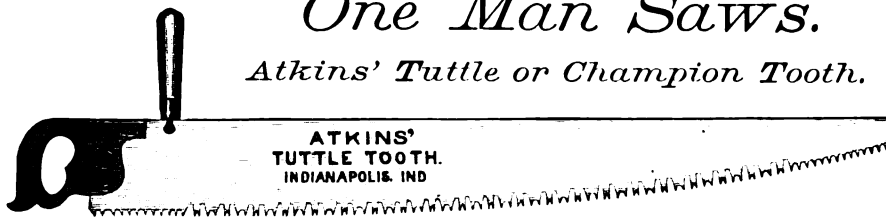

Lengths,	3	3½	4	4½	5 ft.
Each, -	\$2 25	2 68	3 00	3 88	3 75

Atkins' American Tooth.

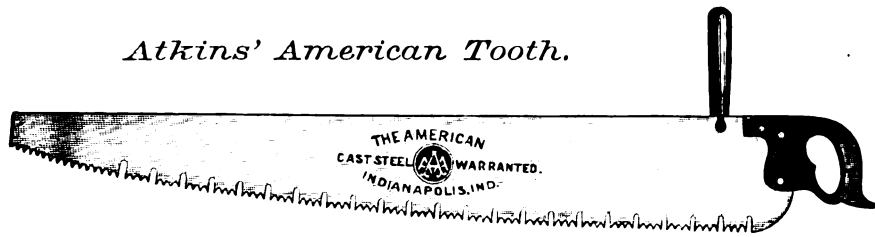

Lengths,	3	3½	4	4½	5 ft.
Each, -	\$2 25	2 68	3 00	3 88	3 75

Saw Handles.

One Man Cross-Cut.



NO.	DESCRIPTION.	PER DOZ.
10	Cherry, Polished Edges, No Screws, for Disston's or Atkins' Saws, -	\$7 00
11	Cherry, Varnished Edges, No Screws, for W. M. & C's Saws, -	7 00
12	Supplementary, - - -	2 25

Cross-Cut Saw Handles.

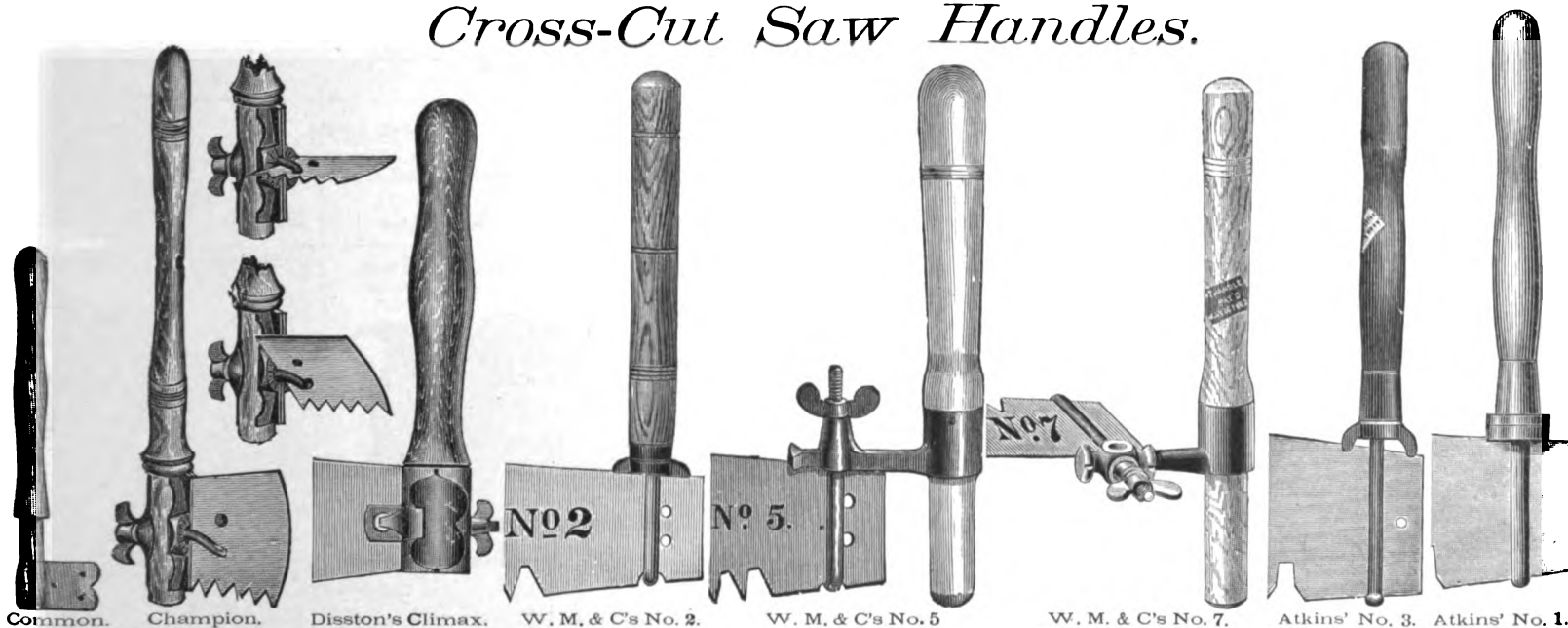

NO.	DESCRIPTION.	PER PAIR.	NO.	DESCRIPTION.	PER PAIR.
9	Common, Hickory, - - - -	\$0 15	5	W. M. & C's, Extension, - - - -	\$0 50
8	Champion, Reversible, - - - -	38	7	W. M. & C's, Extension, Reversible, -	60
4	Disston's, Climax, - - - -	62	3	Atkins', Malleable Loop, - - - -	40
2	W. M. & C's, Malleable Loop, Small Ferrule,	45	1	Atkins', Wrought Loop, Heavy Ferrule,	50

Hand and Rip Saws.

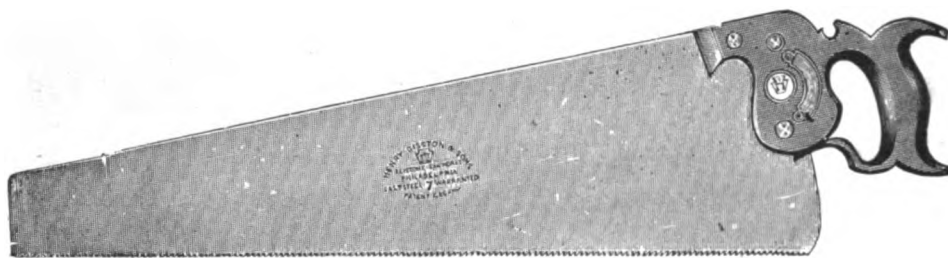

NO.	DESCRIPTION.	PER DOZEN.	
		HAND 26 INCH.	RIP 28 INCH.
7	Disston & Sons' Cast-Steel, Beech Handle, Polished Edge, 4 Improved Screws, Grained Blade and Etched,	\$20 00	\$23 50

26 INCH, 7, 8, 9, 10, 11 AND 12 POINTS. 28 INCH 4½, 5, 5½ AND 6 POINTS. ONE-THIRD DOZEN IN A BOX.

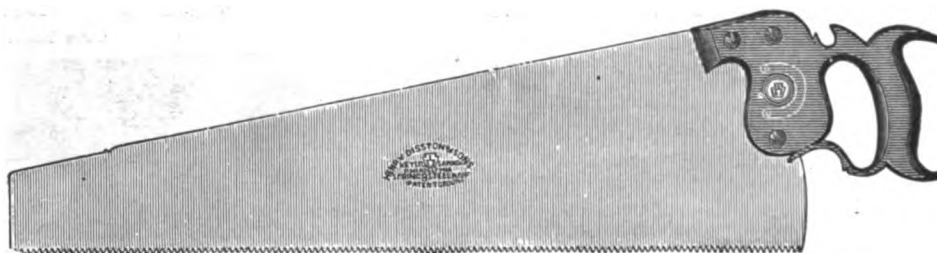

NO.	DESCRIPTION.	PER DOZEN.	
		HAND 26 INCH.	RIP 28 INCH.
8	Disston & Sons' Spring Steel, Apple Handle, Polished Edge, 4 Improved Screws, Grained Blade and Etched,	\$21 00	\$24 00

26 INCH, 7, 8, 9, 10, 11 AND 12 POINTS. 28 INCH, 4½, 5, 5½ AND 6 POINTS. ONE-THIRD DOZEN IN A BOX.

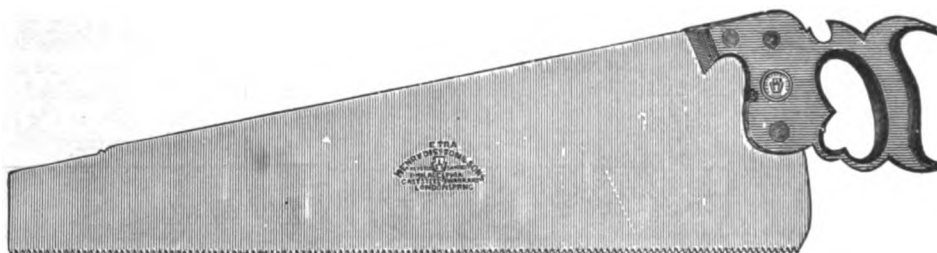

NO.	DESCRIPTION.	PER DOZEN.	
		HAND 26 INCH.	RIP 28 INCH.
9	Disston & Sons' Extra London Spring Steel, Apple Handle, Polished Edge, 4 Improved Screws, Grained Blade and Etched,	\$24 00	\$28 00

26 INCH, 7, 8, 9, 10, 11 AND 12 POINTS. 28 INCH, 4½, 5 AND 5½ POINTS. ONE-THIRD DOZEN IN A BOX.



NO.	DESCRIPTION.	PER DOZEN.	
		HAND 26 INCH.	RIP 28 INCH.
12	Disston & Sons' Extra Refined London Spring Steel, Selected and Highly Polished Blade, Handle Carved and Polished, 4 Raised Brass Screws,	\$30 00	\$34 00

26 INCH, 7, 8, 9, 10, 11 AND 12 POINTS. 28 INCH, 4, 4½, 5, 5½ AND 6 POINTS. ONE-THIRD DOZEN IN A BOX.

Hand and Rip Saws.

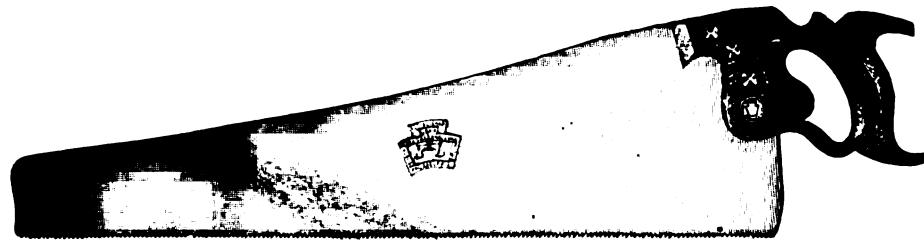

NO.	DESCRIPTION.	PER DOZEN.	
		HAND 26 INCH.	RIP 28 INCH.
76	Disston & Sons' Centennial, Cast Steel, Skew Back, Polished Apple Handle, 4 Rivets,	\$20 50	23 50

26 INCH. 6, 7, 8, 9, 10, 11 AND 12 POINTS. 28 INCH. 4½, 5, 5½ AND 6 POINTS. ONE-THIRD DOZEN IN A BOX.

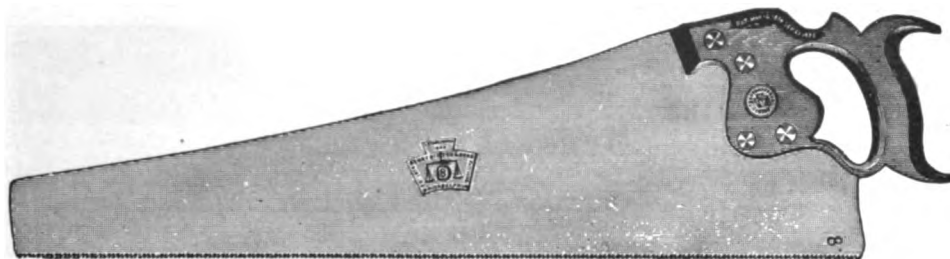

NO.	DESCRIPTION.	PER DOZEN.	
		HAND 26 INCH.	RIP 28 INCH.
D 8	Disston & Sons' Cast Steel, Skew Back, Apple Handle, Polished Edge, 5 Improved Screws, Grained Blade and Etched,	\$22 00	25 00

26 INCH. 6, 7, 8, 9, 10, 11 AND 12 POINTS. 28 INCH. 4, 4½, 5, 5½ AND 6 POINTS. ONE-THIRD DOZEN IN A BOX.

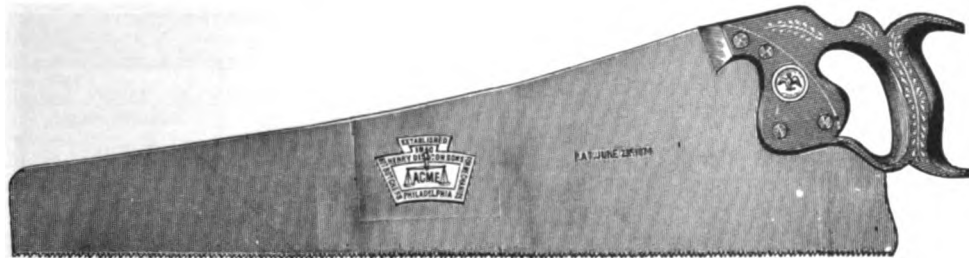

NO.	DESCRIPTION.	PER DOZEN.	
		HAND 26 INCH.	RIP 28 INCH.
120	Disston & Sons' Acme, Extra London Spring Steel, Skew Back, Carved and Polished Apple Handle, 5 Rivets, runs entirely without Set in Dry Seasoned Lumber,	\$38 00	88 00

26 INCH. 8, 9, 10, 11 AND 12 POINTS. 28 INCH. 4½, 5, 5½ AND 6 POINTS. ONE-THIRD DOZEN IN A BOX.

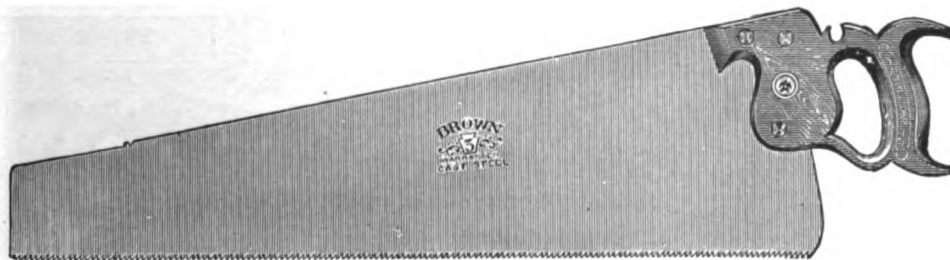

NO.	DESCRIPTION.	PER DOZEN.	
		HAND 26 INCH.	RIP 28 INCH.
3	Brown's, Grained Blade, Beech Handle, Polished Edge, 4 Rivets, Full Width,	\$18 00	16 00

26 INCH. 5, 6, 7, 8 AND 9 POINTS. 28 INCH. 4, 4½, 5 AND 5½ POINTS. ONE-THIRD DOZEN IN A BOX.

Hand and Rip Saws.



NO.	DESCRIPTION.	PER DOZEN.	
		HAND 26 INCH.	
50	Sam Sickles, Cast Steel, Beech Handle, Polished Edge, 3 Rivets, ASSORTED, 6 TO 8 POINTS. HALF DOZEN IN A BOX.	\$6 50	

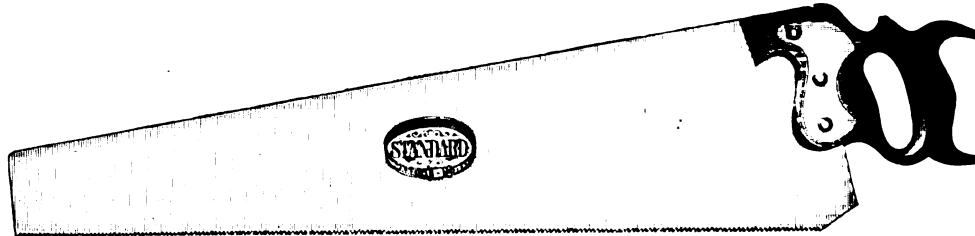

NO.	DESCRIPTION.	PER DOZEN.	
		HAND 26 INCH.	
55	Granger's Cast Steel, Polished Black Walnut Handle, 3 Rivets, Raised Steel Plate, 26 INCH, 5, 6, 7, 8 AND 9 POINTS. HALF DOZEN IN A BOX.	\$8 50	

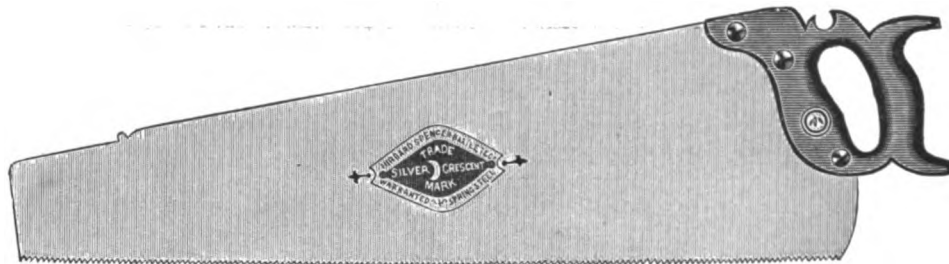

NO.	DESCRIPTION.	PER DOZEN.	
		HAND 26 INCH.	RIP 28 INCH.
110	Silver Crescent, Cast Steel, Bow Belly, Polished Apple Handle, 4 Rivets, Etched Blade, 26 INCH, 5, 6, 7, 8, 9 AND 10 POINTS. 28 INCH, 4, 4½, 5 AND 5½ POINTS. ONE-THIRD DOZEN IN A BOX.	\$17 00	20 50

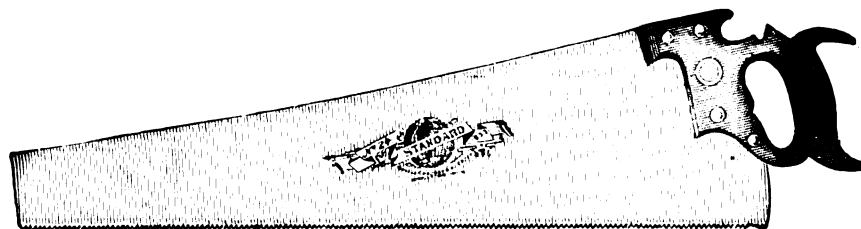

NO.	DESCRIPTION.	PER DOZEN.	
		HAND 26 INCH.	RIP 28 INCH.
24	W. M. & C's, Cast Steel, Skew Back, Grained Blade, Beech Handle, Polished Edge, 5 Rivets, 26 INCH, 6, 7, 8, 9, 10, 11 AND 12 POINTS. 28 INCH, 4½, 5, 5½ AND 6 POINTS. ONE-THIRD DOZEN IN A BOX.	\$20 00	23 50

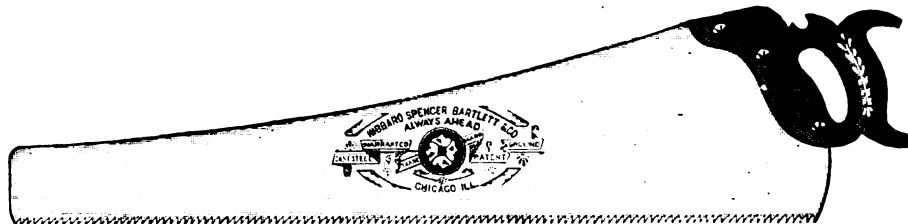

NO.	DESCRIPTION.	PER DOZEN.	
		HAND 26 INCH.	RIP 28 INCH.
26	Always Ahead, Extra Cast Steel, Grained Blade, Skew Back, Beech Handle, Polished and Etched, 4 Plated Rivets, 26 INCH, 6, 7, 8, 9, 10, 11 AND 12 POINTS. 28 INCH, 4½, 5, 5½ AND 6 POINTS. ONE-THIRD DOZEN IN A BOX.	\$21 00	24 50

Combination Hand Saws.

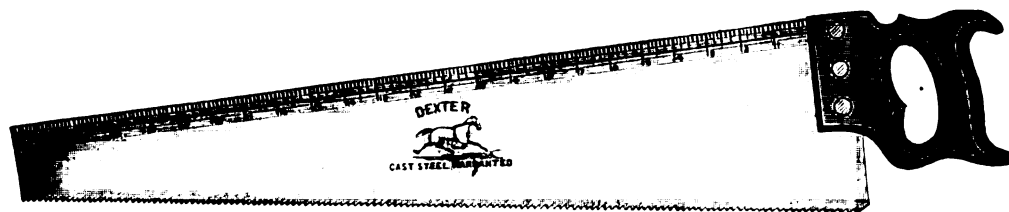

NO.	DESCRIPTION.	PER DOZEN.
60	Dexter, Combination, with 24 inch Square and Rule, Straight Edge, 8 Rivets, 26 inch, - - - - -	\$8 00

ASSORTED, 6 TO 8 POINTS. HALF DOZEN IN A BOX.

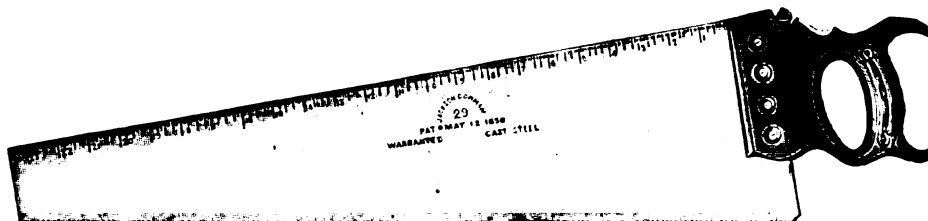

NO.	DESCRIPTION.	PER DOZEN.
29	Patent Combination Saw, with 24 inch Square and Rule, Straight Edge and Scratch Awl, Plain Tooth, 26 inch, - - - - -	\$11 00

ASSORTED, 6 TO 8 AND 7 TO 9 POINTS. ONE-THIRD DOZEN IN A BOX.

Panel Saws.



No. 7. Disston & Sons' Warranted, Beech Handle, Polished Edge, Etched, Grained Blade.

Inches, -	16	18	20	22	24
Per Dozen,	\$18 00	14 00	16 00	18 00	19 00

7, 8, 9, 10, 11 AND 12 POINTS. ONE-THIRD DOZEN IN A BOX.

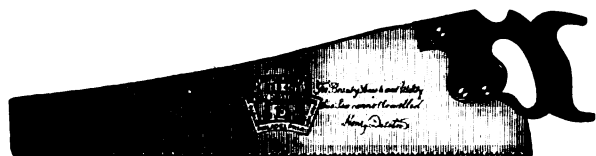

No. D, 8. Disston & Sons' Cast Steel, Warranted, Skew Back, Polished Apple Handle, 4 Improved Screws, Grained Blade and Etched.

Inches, - -	18	20	22
Per Dozen, -	\$16 00	17 50	19 50

8, 9, 10, 11 AND 12 POINTS. ONE-THIRD DOZEN IN A BOX.

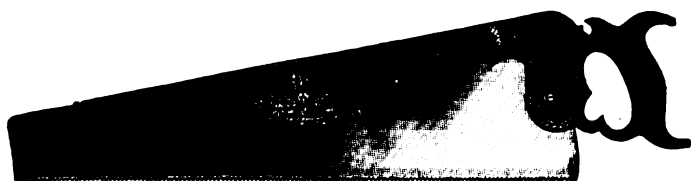

No. 12. Disston & Sons' Extra London Spring Steel Blade, Selected and Highly Polished Apple Handle, Carved, 4 Improved Screws.

Inches, - -	18	20	22
Per Dozen, -	\$22 00	24 00	26 00

8, 9, 10, 11 AND 12 POINTS. ONE THIRD DOZEN IN A BOX.



No. 50. Sam Sickels' Cast Steel, Beech Handle, Polished Edge,

Inches, -	14	16	18	20	22
Per Dozen,	\$5 25	5 50	5 75	6 00	6 25

14 INCH, 7 TO 9, 8 TO 10, 9 TO 11 POINTS; 16 TO 22 INCH, 7 TO 9, 8 TO 10, 9 TO 11, 10 TO 12 POINTS. HALF DOZEN IN A BOX.

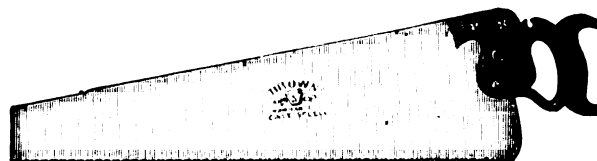

No. 3. Brown's, Beech Handle, Polished Edge, 3 Rivets, Grained Blade, Etched.

Inches, -	16	18	20	22
Per Dozen,	\$8 00	9 00	10 00	11 00

7, 8, 9, 10, 11 AND 12 POINTS. ONE THIRD DOZEN IN A BOX.



No. 24. Wheeler, Madden & Clemson's Standard, Cast Steel, Warranted, Skew Back, Beech Handle, Polished Edge, 5 Rivets, Grained Blade and Etched.

Inches, - -	18	20	22
Per Dozen,	\$14 00	16 00	18 00

9, 10, 11 AND 12 POINTS. ONE-THIRD DOZEN IN A BOX.

Saws.

Back.

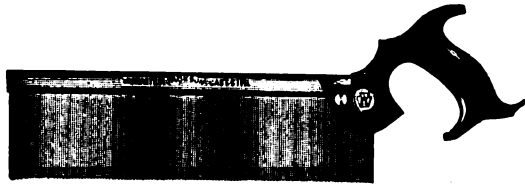

No. 1. Jackson's, Beech Handle, Polished Edge, Blue Back.

Inches, -	10	12	14	16
Per Dozen,	\$10 00	12 00	14 00	16 00

ONE-THIRD DOZEN IN A BOX.

Back.



No. 7. Disston & Sons', same as No. 4, with Polished Steel Back.

Inches, -	10	12	14	16
Per Dozen,	\$15 00	17 00	19 00	21 00

ONE-THIRD DOZEN IN A BOX.

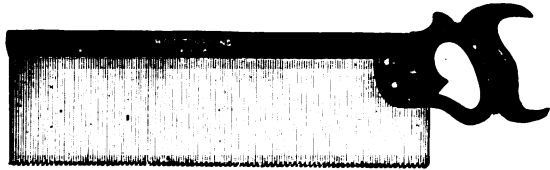

No. 4. Disston & Sons', Apple Handle, Polished Edge, Blue Back.

Inches, - -	8	10	12	14	16
Per Dozen,	\$13 00	14 00	16 00	18 00	20 00

ONE-THIRD DOZEN IN A BOX.

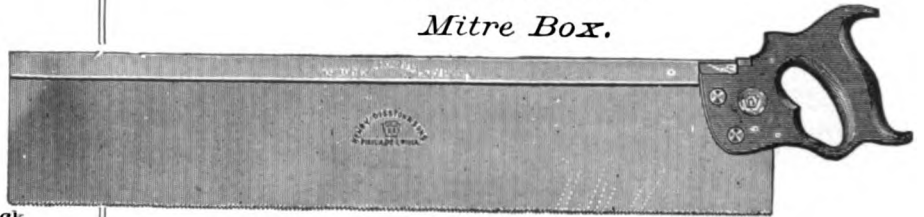

Mitre Box.

NO.	DESCRIPTION.	PER DOZEN.
4	20 inch, Disston & Sons' Apple Handle, Polished Edge, Steel Back, 4 in. under back,	\$24 00

ONE-THIRD DOZEN IN A BOX.

Compass.

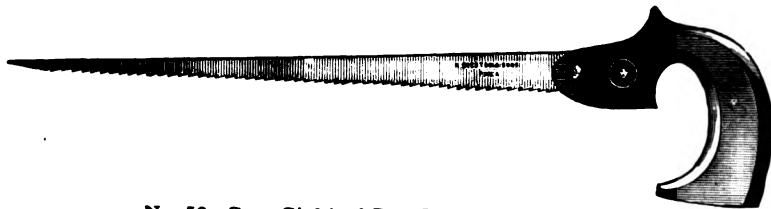

No. 50. Sam Sickles' Cast Steel, Beech Handle.

Inches, - - -	10	12	14
Per Dozen, - -	\$4 00	4 25	4 50

HALF DOZEN IN A BOX.

Key Hole.



DESCRIPTION.	PER DOZEN.
Disston's Key Hole Saw, with Iron Pad, - -	\$2 50

ONE DOZEN IN A BOX.

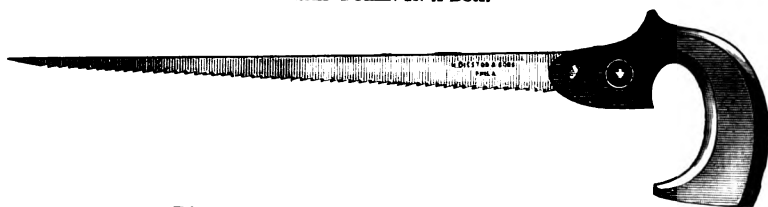

Disston & Sons' Cast Steel, Apple Handle.

Inches, -	10	12	14	16
Per Dozen,	\$4 25	4 50	4 75	5 00

HALF DOZEN IN A BOX.

Saw Pads.



DESCRIPTION.	PER DOZEN.
German Wood Saw Pads, - - - -	\$5 00

HALF DOZEN IN A PACKAGE.

Nests of Saws.

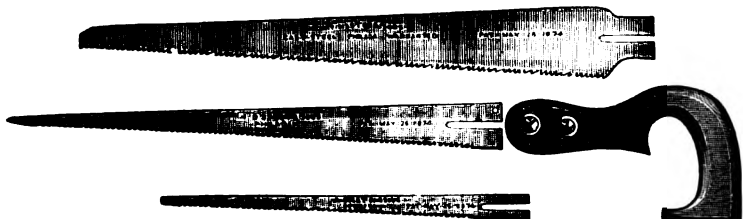

DESCRIPTION.	PER DOZEN NESTS.
Combines one each Key Hole, Compass, and Table or Pruning Saw, - - - -	\$12 00

QUARTER DOZEN NESTS IN A BOX.

Key Hole Saw Blades.

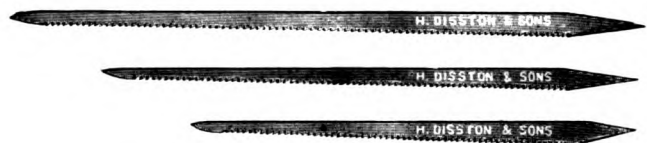

DESCRIPTION.	PER DOZEN.
Disston & Sons' Cast Steel, Ground, Set and Sharpened, Assorted Sizes, - - - -	\$1 50

ONE DOZEN IN A BOX.

Hack Saws.

Griffin's.

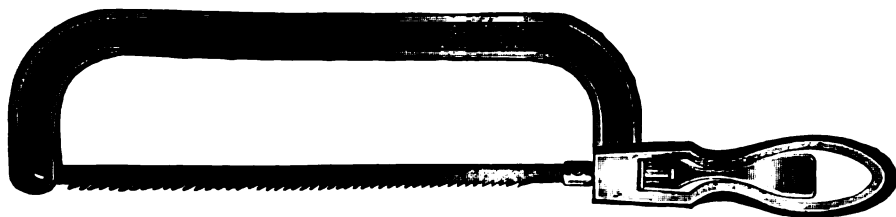

No. 30, Japanned Frame.

Inches, - -	8	9	10
Per Dozen, -	\$16 00	17 00	18 00

ONE SAW IN A BOX, COMPLETE WITH ONE DOZEN BLADES.

Disston's.

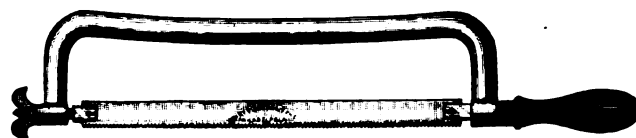

Reversible Frame.

Inches, - -	8	10	12
Per Dozen, -	\$13 25	13 75	14 25

ONE-THIRD DOZEN IN A PACKAGE.

Hack Saw Frames.

Crown.

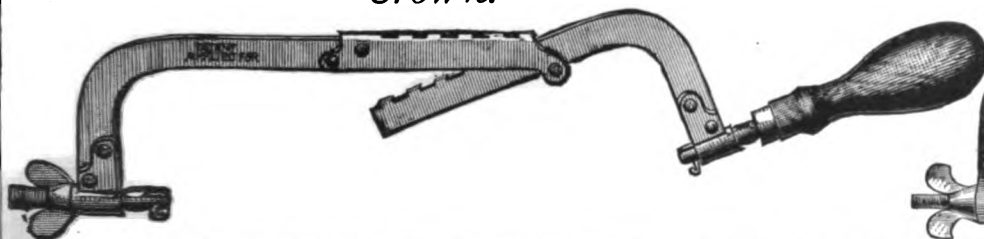

Star.

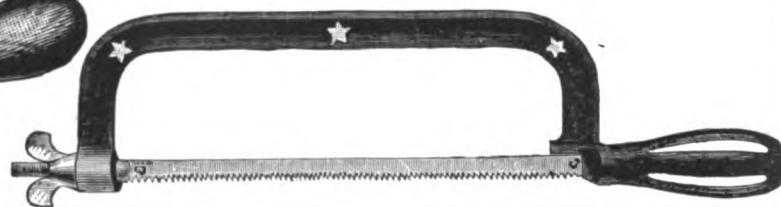

NO.	DESCRIPTION.	PER DOZEN.
1	Crown Extension, Nickel Plated Steel Frame, Enameled Handle, Extends from 8 to 10 inches,	\$12 00
4	Star, Japanned Frame, for 9 inch Blades,	4 80

CROWN, ONE IN A BOX. STAR, ONE IN A PACKAGE.

Pruning Saws.

Brown's and Disston's.

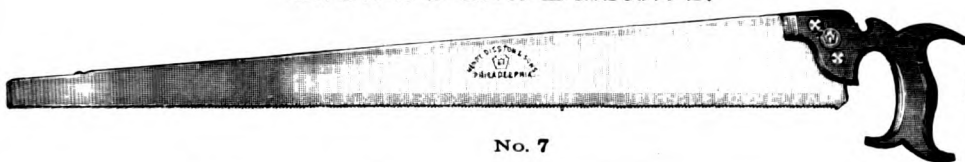

No. 7

Duplex.

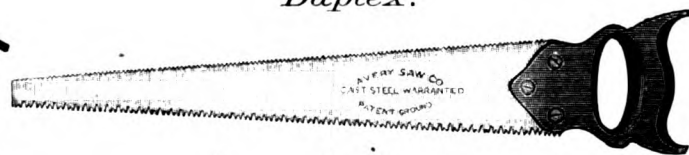

No. 40.

NO.	DESCRIPTION.	PER DOZEN.
8	Brown's, Beech Handle, Polished Edge, 3 Rivets, Grained Blade and Etched, 20 inch,	\$ 8 25
7	Disston & Sons', Cast Steel, Apple Handle, Polished Edge, 3 Rivets, 20 inch,	11 00
40	Duplex Pruning Saws, 18 inch,	7 75

ONE-THIRD DOZEN IN A BOX.

Crescent.



DESCRIPTION.	PER DOZEN.
Henry Disston & Sons' Crescent, California Pruning Saw, 12 inch Blade,	\$6 50

HALF DOZEN IN A BOX.

Pruning Saw and Knife.

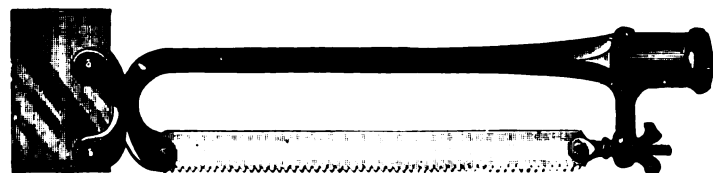

DESCRIPTION.	PER DOZEN.
Disston & Sons' Improved Pole Pruner, Screw Socket, Japanned Frame,	\$11 00

QUARTER DOZEN IN A BOX.

Kitchen Saws.

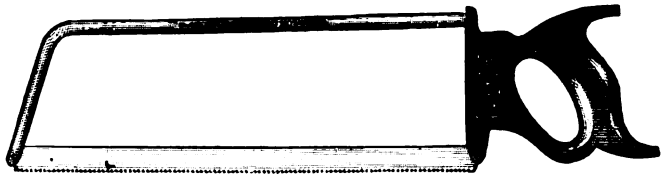

No. 0, Disston & Sons' Oval Back.

Inches, - -	12	14
Per Dozen, - -	\$8 50	9 25

HALF DOZEN IN A BOX.

Saw Knives.



DESCRIPTION.	PER DOZEN.
Cast Steel Blade, - - - -	\$5 25

ONE DOZEN IN A BOX.

Butchers' Saws.

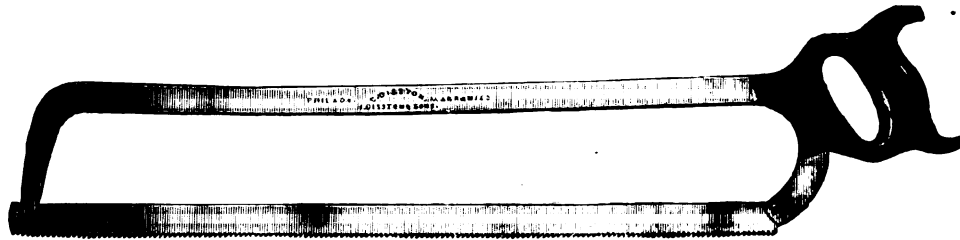

No. 2, Disston & Sons' Flat Back.

Inches, - - -	16	18	20	22	24
Per Dozen, - -	\$12 50	13 25	14 00	14 75	15 50

ONE-THIRD DOZEN IN A BOX.

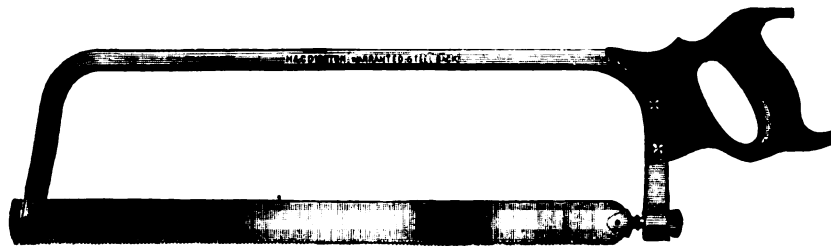

No. 1, Disston & Sons' Oval Back.

Inches, - - -	20	22	24	26	28
Per Dozen, - -	\$18 00	19 00	20 00	21 00	22 00

ONE-THIRD DOZEN IN A BOX.

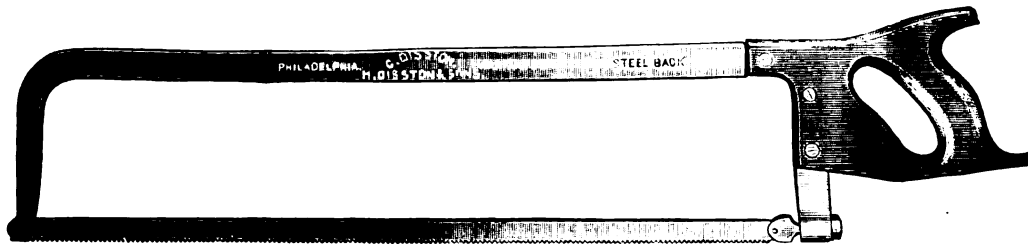

No. 7, Disston & Sons' Flat Steel Back.

Inches, - - - -	24	26	28
Per Dozen, - - - -	\$19 00	20 00	21 00

ONE-THIRD DOZEN IN A BOX.

Saw Blades.

Butchers'.

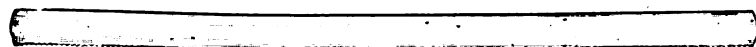

1 1/4 inch Wide.

Inches,	18	20	22	24	26	28
Per Doz.	\$5 25	5 50	5 75	6 00	6 25	6 50

ONE DOZEN IN A BOX.

Clock Spring Butchers'.

3/4 inch Wide.

Inches,	-	22	24	26	28
Per Dozen,	-	\$6 75	7 00	7 25	7 50

ONE DOZEN IN A PACKAGE.

Star Butchers'.

3/4 inch Wide.

Inches,	14	16	18	20	22	24	26
Per Doz.	\$1 08	1 08	1 20	1 20	1 32	1 32	1 44

ONE DOZEN IN A PACKAGE.

Hack.



Star.

Inches,	-	8	9	10
Per Dozen,	-	\$0 65	70	85

ONE DOZEN A PACKAGE.

Disston's.

Inches,	-	8	10	12
Per Dozen,	-	\$2 80	3 25	3 75

ONE DOZEN IN A BOX.

Griffin's.

Inches,	-	8	9	10
Per Gross,	-	\$10 50	11 25	12 00

ONE DOZEN IN A BOX.

Wood.

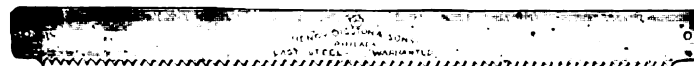

NO.	DESCRIPTION.	PER DOZEN.
4	Jackson's Cast Steel, Set and Sharpened, 30 inch,	\$8 00
6	Disston & Sons' Cast Steel, Patent Ground and Tempered, Set and Sharpened, 30 inch,	6 00
6	Same as above, 36 inch long, and 9 1/2 points to the inch,	7 50
9	Disston & Sons' Cast Steel, Patent Ground and Tempered, Set and Sharpened, 30 inch,	7 00
11	Disston & Sons' Extra Cast Steel (for wood Sawyers), Set and Sharpened, 30 inch,	9 50

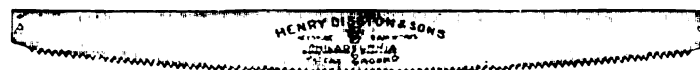

16	Disston & Sons' Improved Round Breasted, Cast Steel, Patent Ground and Tempered, Set and Sharpened, 30 inch,	\$6 00
----	--------------------------------------------------------------------------------------------------------------	--------

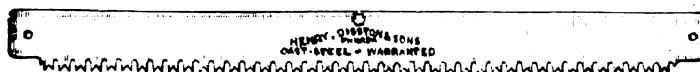

77	H., S., B. & Co's. Improved Cast Steel, Set and Sharpened, 30 inch,	\$6 50
----	---------------------------------------------------------------------	--------

ONE DOZEN IN A PACKAGE.

Turning and Felloe Webs.

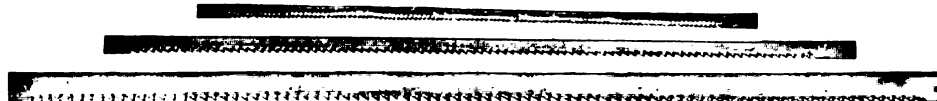

Length,	10	12	14	16	18	20	22	24	26	28	30	32	34	36
Widths,	1 3/8 to 1/2	1 3/8 to 5/8	1 3/8 to 5/8	1/2 to 3/8	1/2 to 1/2	1/2 to 5/8	1/2 to 5/8	1/2 to 3/4	1/2 to 3/4	1/2 to 7/8	1/2 to 1	1/2 to 1	1/2 to 1	1/2 to 1
Per Dozen,	\$1 85	1 45	1 60	1 80	2 00	2 25	2 50	2 80	3 10	3 45	3 80	4 20	4 60	5 00

Saw Screws.



No. 1.



No. 2.

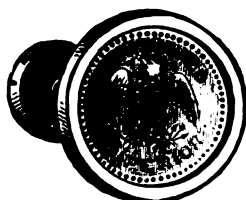

No. 4.



No. 5.



No. 6.

NO.	DESCRIPTION.	PER GROSS.
1	Brass Screws, Centennial,	\$2 80
2	Brass Screws, Centennial,	3 25
3	Brass Screws, Centennial, Small Eagle,	4 75
4	Brass Screws, Centennial, Large Eagle,	5 75
5	Raised,	5 00
6	Iron Screws,	5 00

HALF GROSS IN A BOX.

Wood Saws.

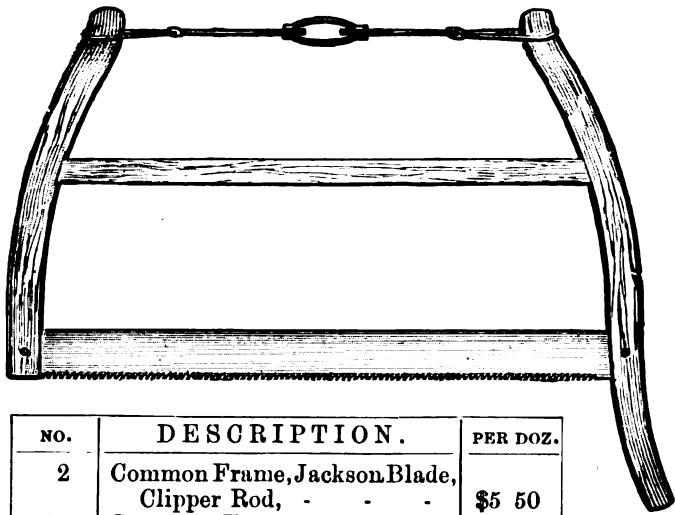

NO.	DESCRIPTION.	PER DOZ.
2	Common Frame, Jackson Blade, Clipper Rod, - - -	\$5 50
15	Common Frame, No. 6 Disston's Blade, Clipper Rod, - - -	9 00

HALF DOZEN IN A BOX.

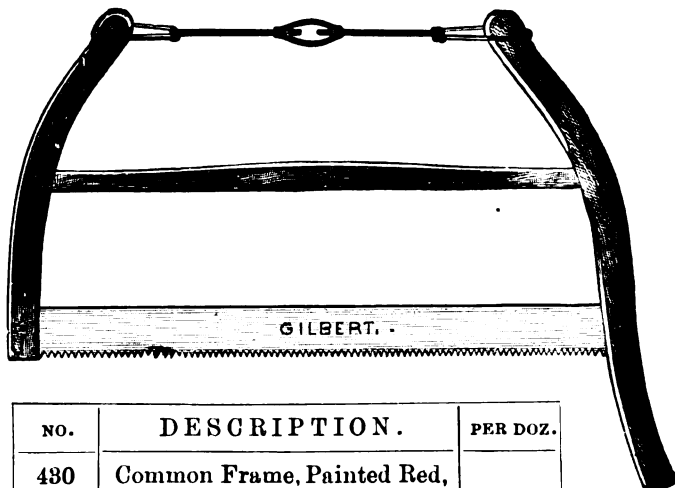

NO.	DESCRIPTION.	PER DOZ.
430	Common Frame, Painted Red, Clipper Rod, 2 inch Blade, Set and Filed, - - -	\$6 75

HALF DOZEN IN A BOX.

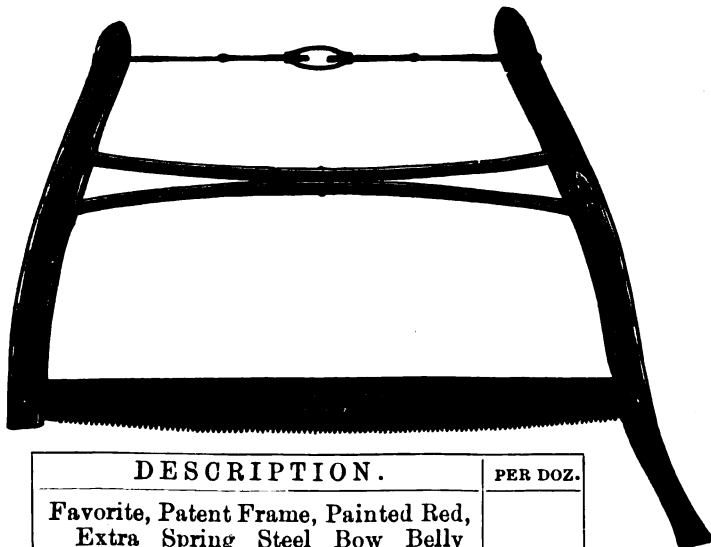

DESCRIPTION.	PER DOZ.
Favorite, Patent Frame, Painted Red, Extra Spring Steel Bow Belly Blade, Clipper Rod, - - -	\$9 50

HALF DOZEN IN A BOX.

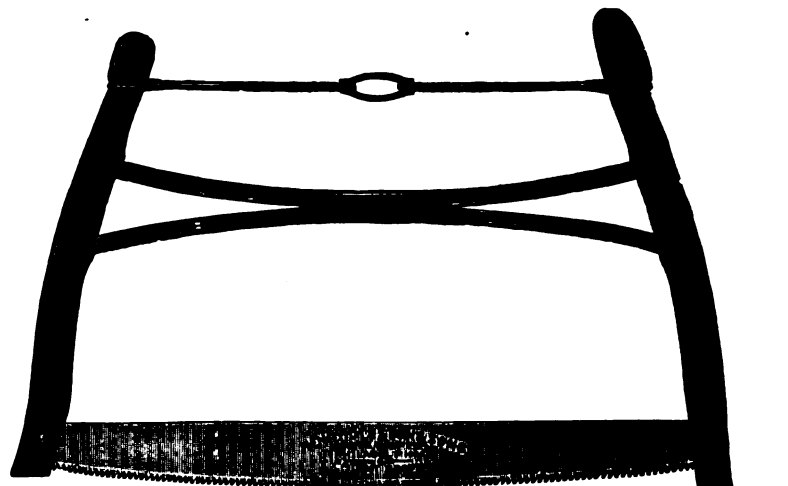

No. 40.

NO.	DESCRIPTION.	PER DOZ.
140	Patent Frame, Painted Red, with H., S., B. & Co's Extra Thin Back, Bow Belly Blade, Tinned Rod, - - -	\$ 9 00
40	Same as No. 140, with Disston's Special No. 6 Blade, - - -	10 50

HALF DOZEN IN A BOX.

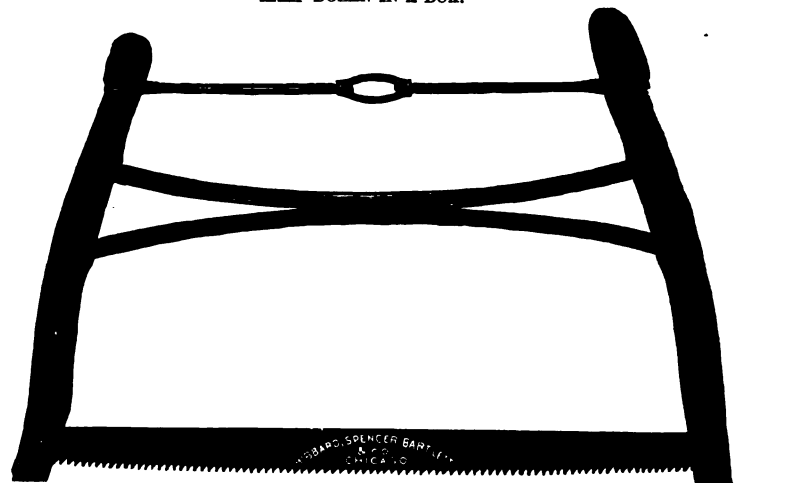

No. 145.

NO.	DESCRIPTION.	PER DOZ.
145	Patent Frame, Painted Red, with H., S., B. & Co's Extra Thin Back Clock Spring Blade, Tinned Rod, - - -	\$ 9 75
45	Same as No. 145, with Disston's Clock Spring Blade, - - -	12 50

HALF DOZEN IN A BOX.

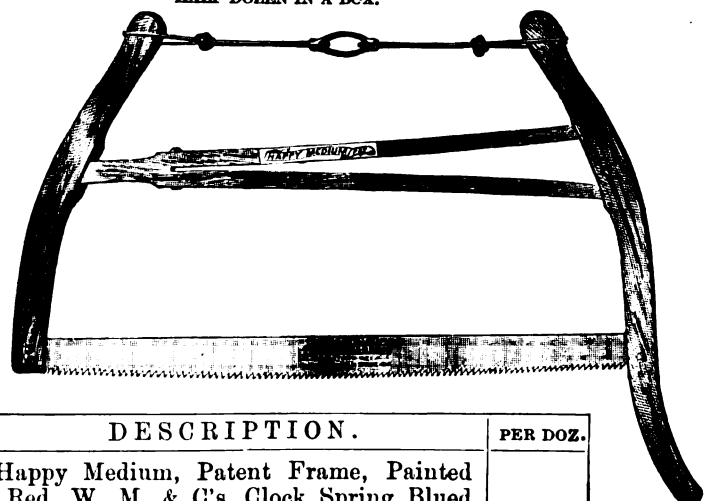

DESCRIPTION.	PER DOZ.
Happy Medium, Patent Frame, Painted Red, W. M. & C's Clock Spring Blued Blade, Clipper Rod, - - -	\$10 50

HALF OR ONE DOZEN IN A BOX.

Wood Saws.

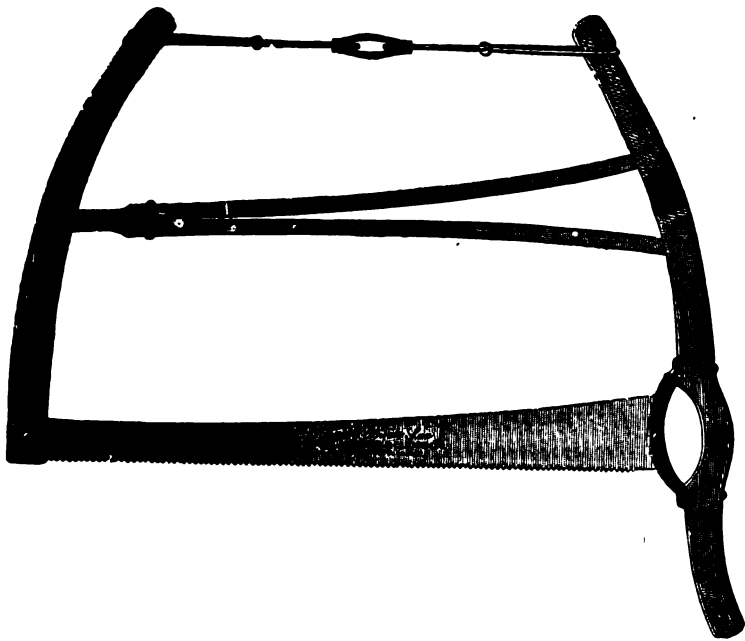

DESCRIPTION.	PER DOZEN.
Handy, Patent Frame, Painted Red, W. M. & C's Patent Blade, Clipper Rod, - - -	\$12 00

HALF DOZEN IN A BOX.

Wood Saw Frames.

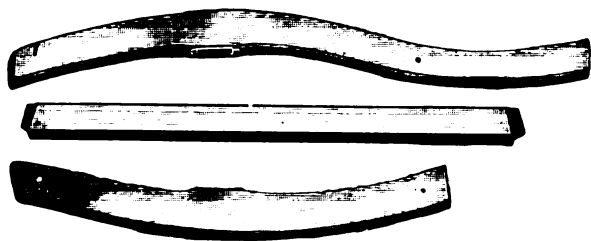

NO.	DESCRIPTION.	PER DOZEN.
1	Common Frame, Plain, - - -	\$1 50
2	Common Frame, Painted, - - -	3 00
	Short End Pieces, Plain, - - -	50

SIX DOZEN IN CRATE.

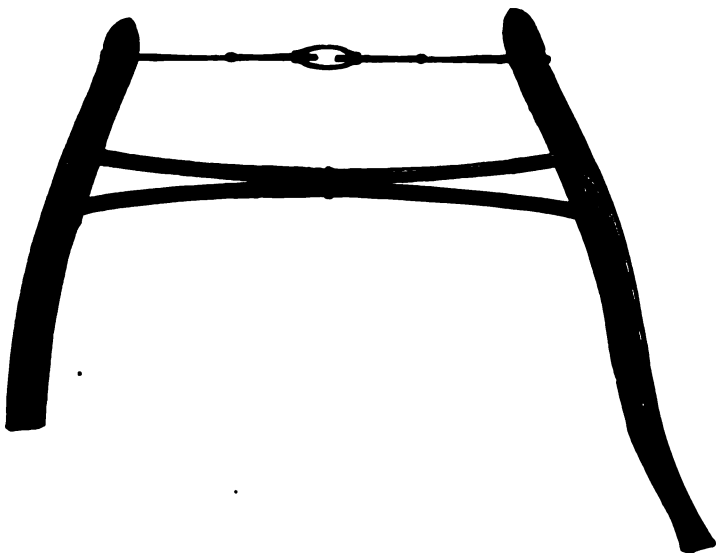

NO.	DESCRIPTION.	PER DOZEN.
50	Patent Braced Frame, Painted Red, with Saw Rod, - - -	\$6 00

Boys' Wood Saws.



Painted Red.

DESCRIPTION.	PER DOZEN.
Cut-I-Cure-U, Jr., Wood Saw and Buck, -	\$ 8 25
Boys' Favorite, Wood Saw and Buck, Large,	12 00

ONE IN A BOX.

Saw Bucks.



DESCRIPTION.	PER DOZEN.
Folding Saw Bucks, - - - - -	\$3 75

HALF DOZEN IN A CRATE.

Saw Rods.



DESCRIPTION.	PER DOZEN.
Clipper Saw Rods, - - - - -	\$1 10

ONE DOZEN IN A PACKAGE.



DESCRIPTION.	PER DOZEN.
Favorite Saw Rod, Patent Loop, - - -	\$1 50

HALF DOZEN IN A PACKAGE.

Corn Knives and Hooks.

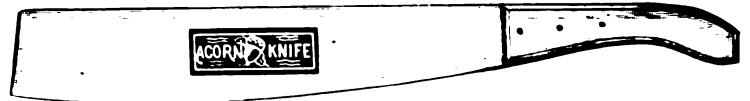
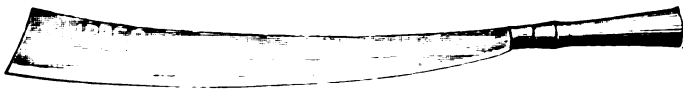

DESCRIPTION.	PER DOZEN.
Clipper Corn Knives, Cast Steel, Painted Red, Handle Riveted on, - - - - -	\$3 00
Acorn, Corn Knives Cast Steel, Painted Green, Three Rivets, - - - - -	2 75

CLIPPER, ONE DOZEN IN STRAW; ACORN, ONE DOZEN IN A BOX.

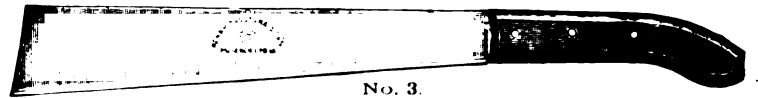

NO.	DESCRIPTION.	PER DOZEN.
IXL	Corn Knives, Cast Steel, Polished, Three Rivets, - - - - -	\$3 50
2	Disston's Corn Knives, Cast Steel, Polished, Three Rivets, - - - - -	4 25
3	Disston's Corn Knives, Cast Steel, Polished, Three Rivets, - - - - -	4 25

ONE DOZEN IN A PACKAGE.